

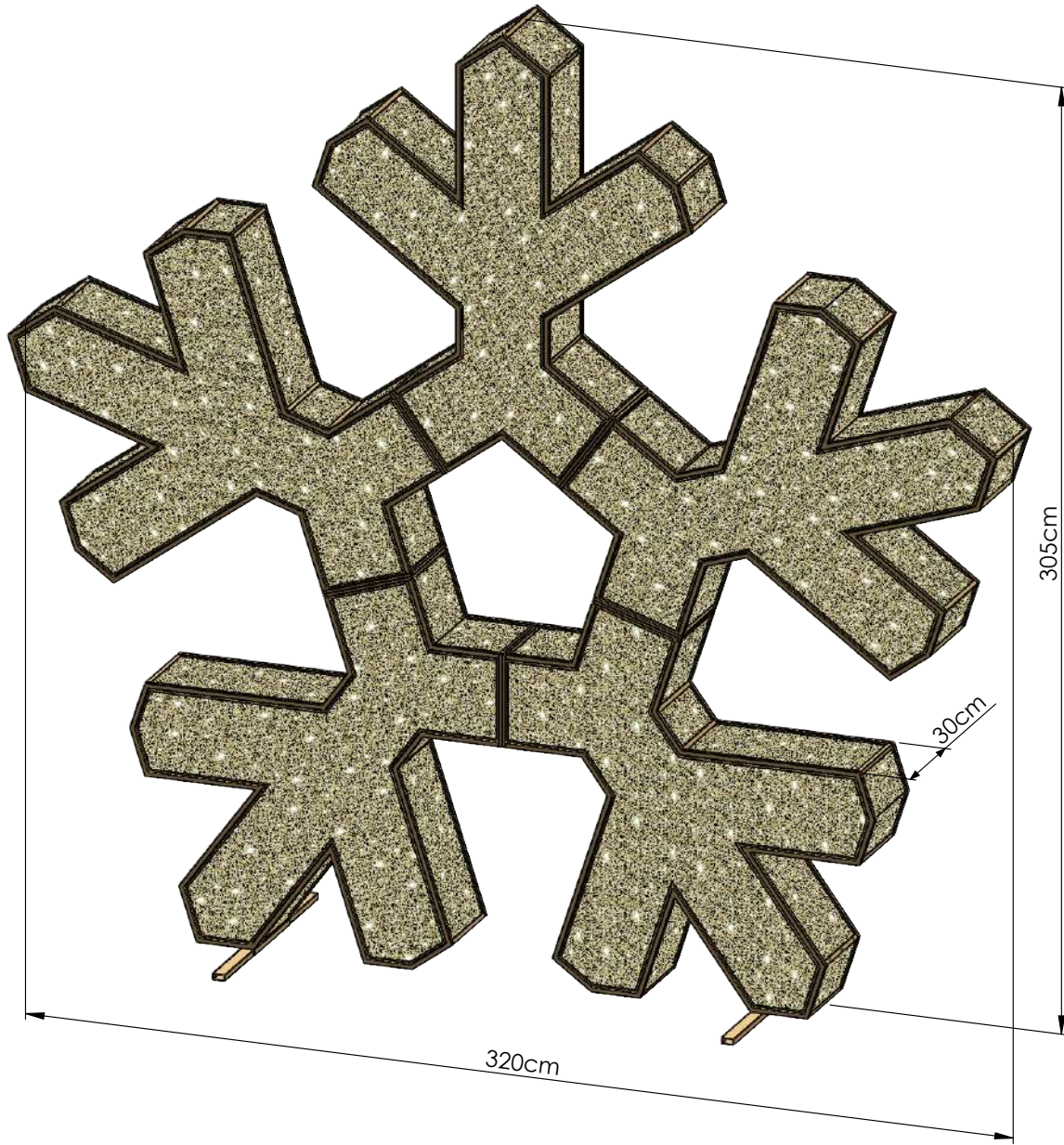

SNOWFLAKE_10'

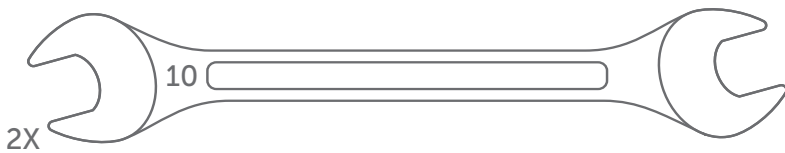

TOOLS NEEDED





SNOWFLAKE_10'

24x		2x	
1x Hex Bolt DIN933 Inox A2 M6x35	1x Grower washer DIN127 Inox A2 M6	1x Lifting Eye Nut DIN582 M6	
2x Plain Washer DIN125A Inox A2 M6	1x Nut DIN934 Inox A2 M6		

Into the palstic bag

5x part 1

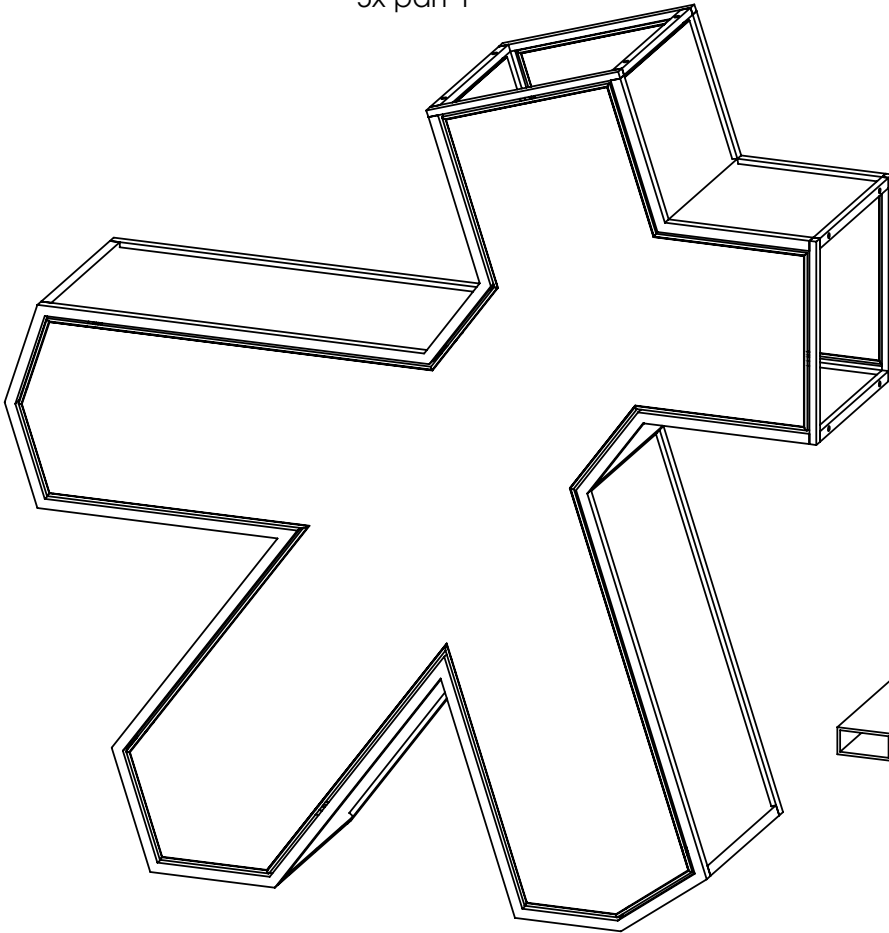

2x part 2

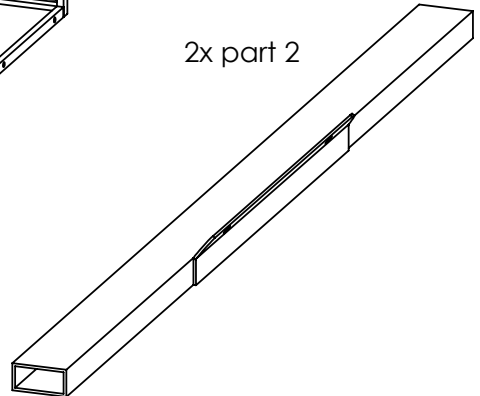



SNOWFLAKE_10'

1

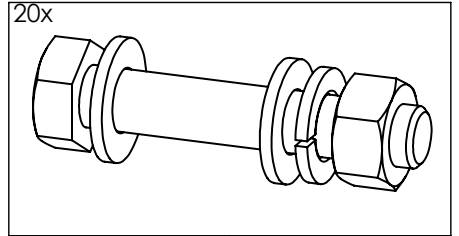

1x Hex Bolt DIN933 Inox A2 M6x35	1x Grower washer DIN127 Inox A2 M6
2x Plain Washer DIN125A Inox A2 M6	1x Nut DIN934 Inox A2 M6

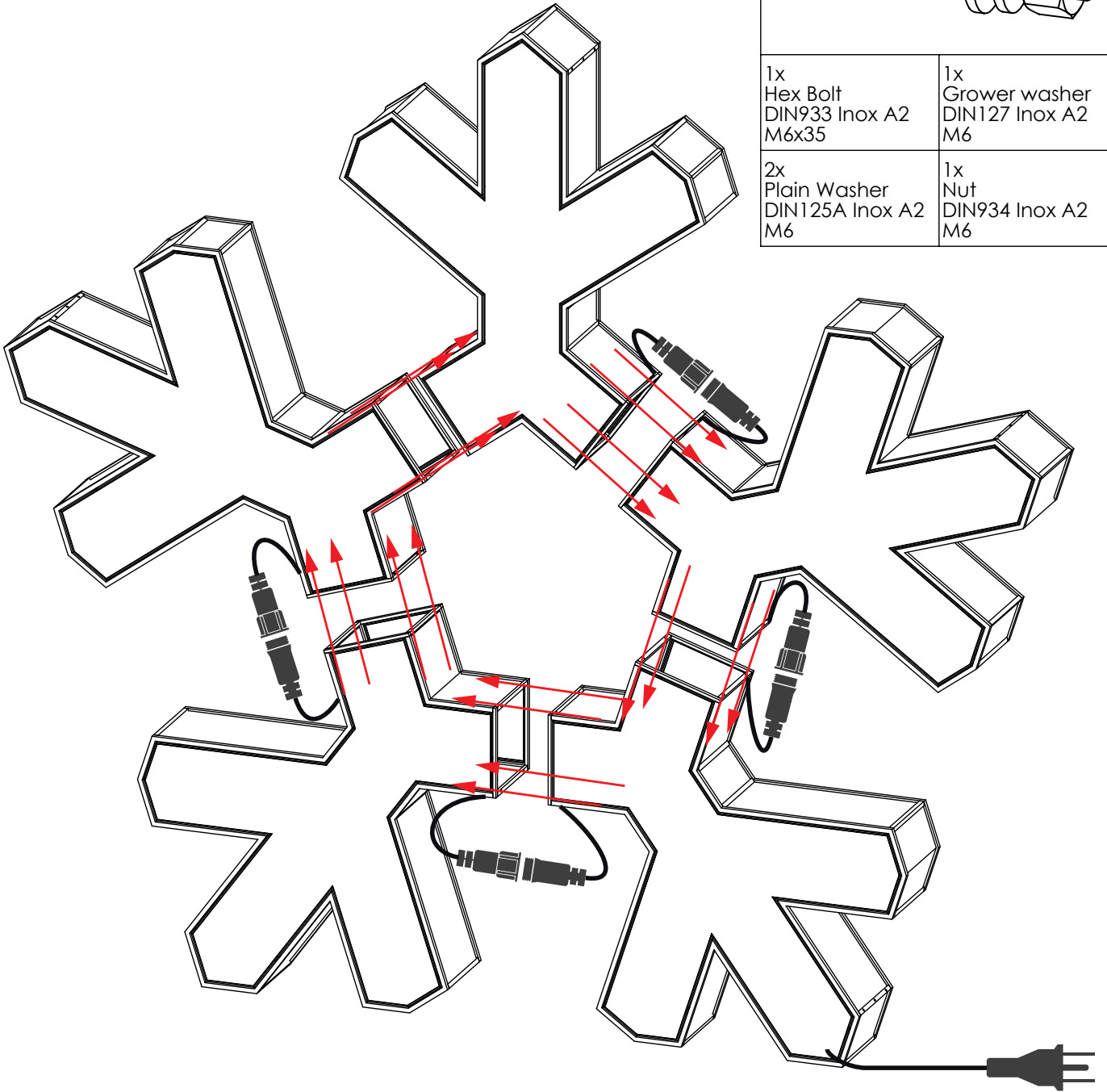



SNOWFLAKE_10'

For standing

2

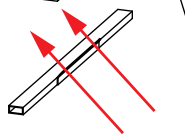
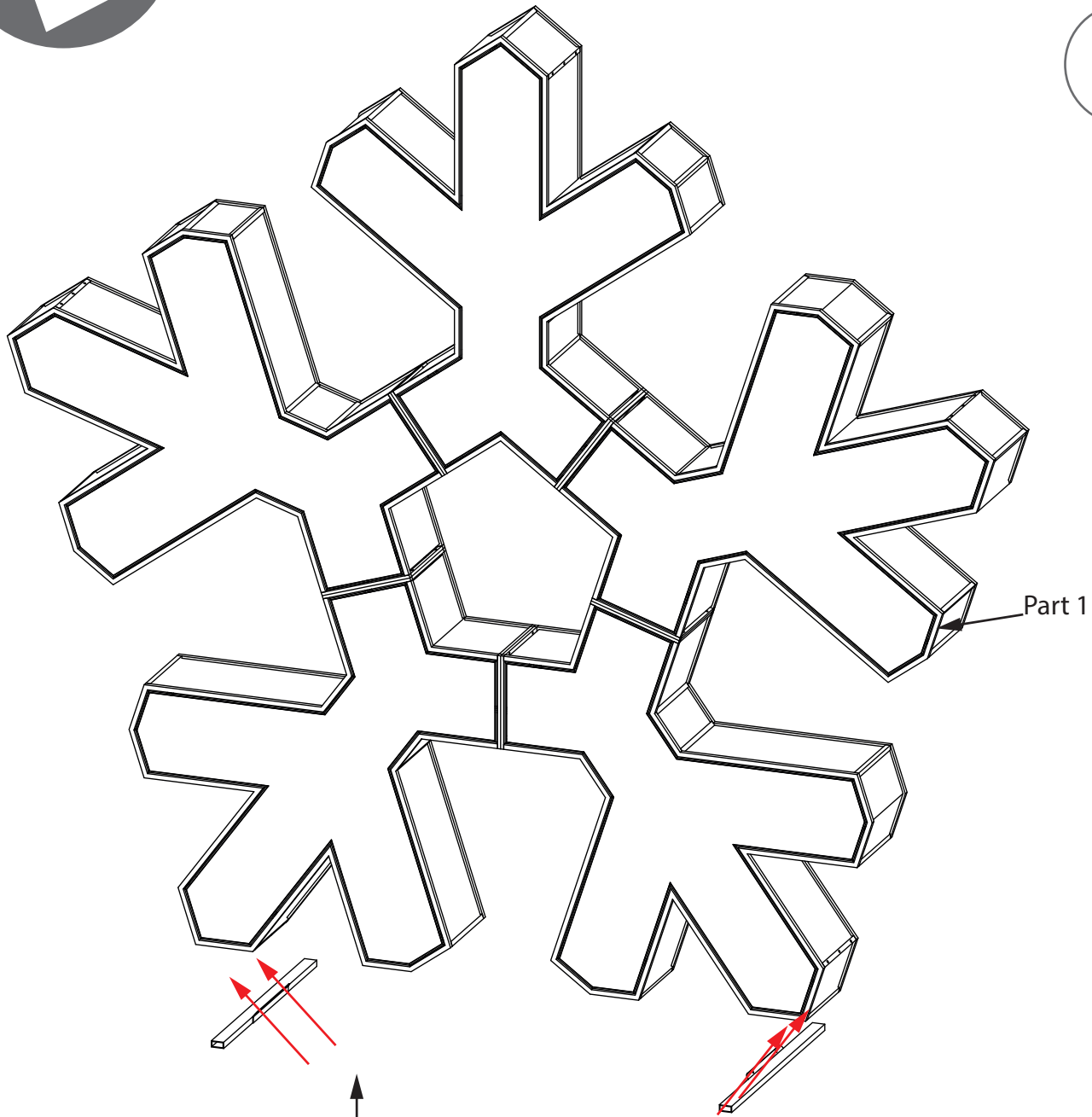

Part 2

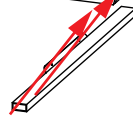

Part 2

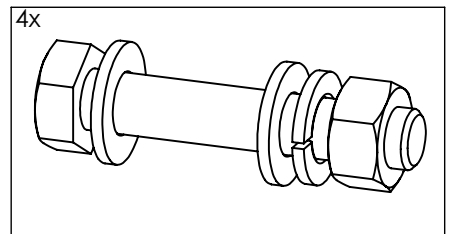

1x
Hex Bolt
DIN933 Inox A2
M6x35

1x
Grower washer
DIN127 Inox A2
M6

2x
Plain Washer
DIN125A Inox A2
M6

1x
Nut
DIN934 Inox A2
M6



SNOWFLAKE_10'

For hanging

slings are
not included

2

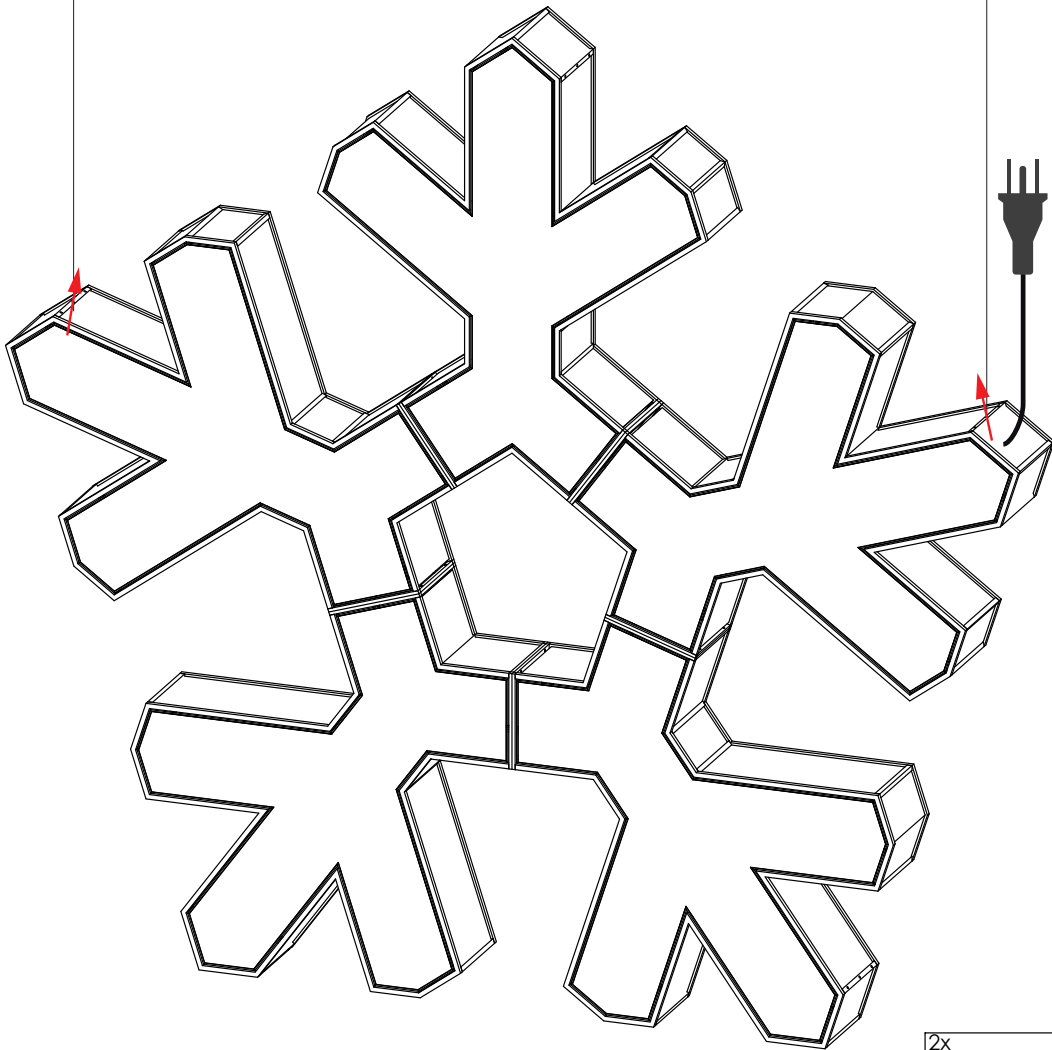

2x	
1x Hex Bolt DIN933 Inox A2 M6x35	1x Grower washer DIN127 Inox A2 M6
1x Plain Washer DIN125A Inox A2 M6	1x Lifting Eye Nut DIN582 M6